

GRADE 3
Mathematics
STAAR Alternate 2

Administered April 2019
RELEASED

MATHEMATICS

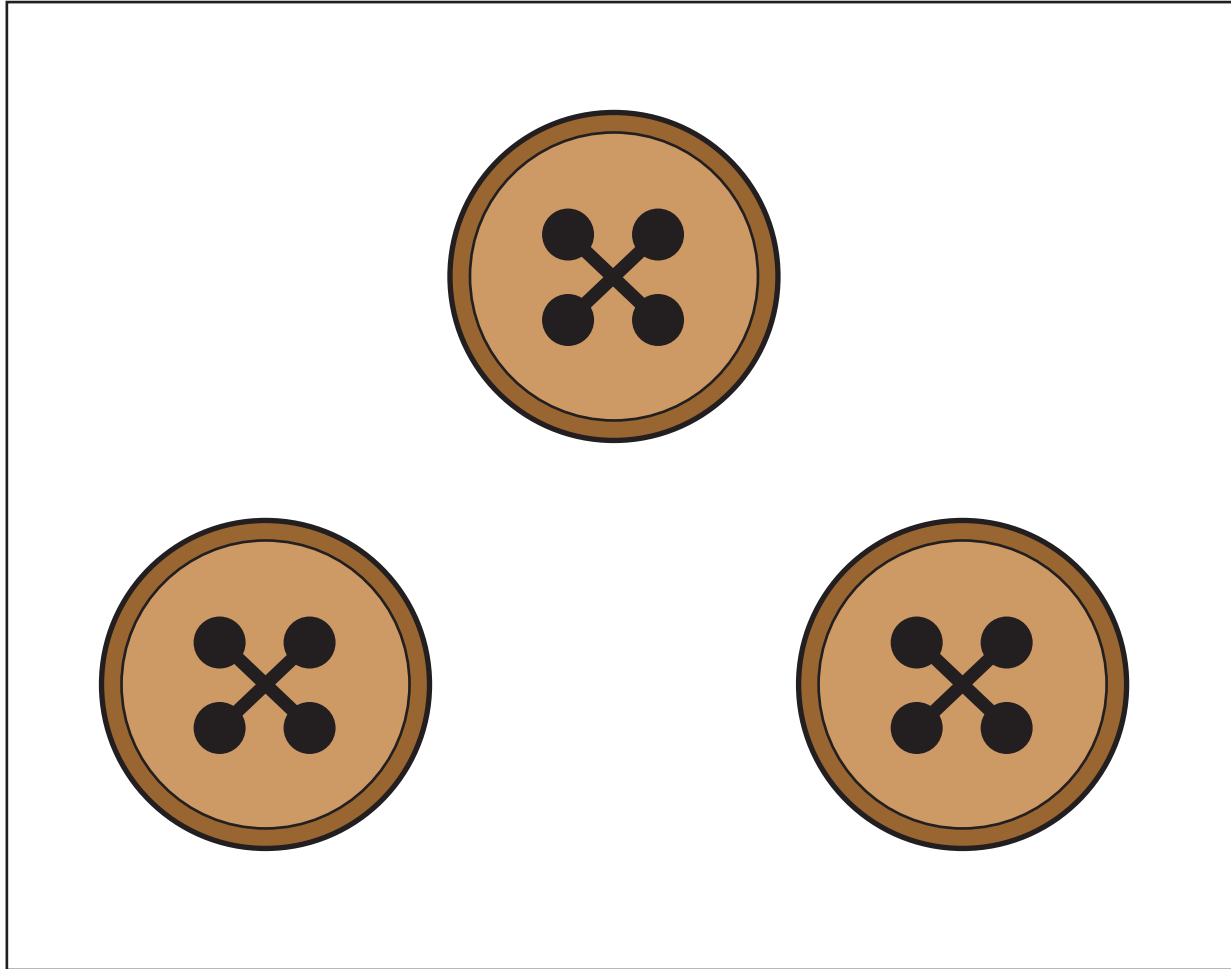

2a

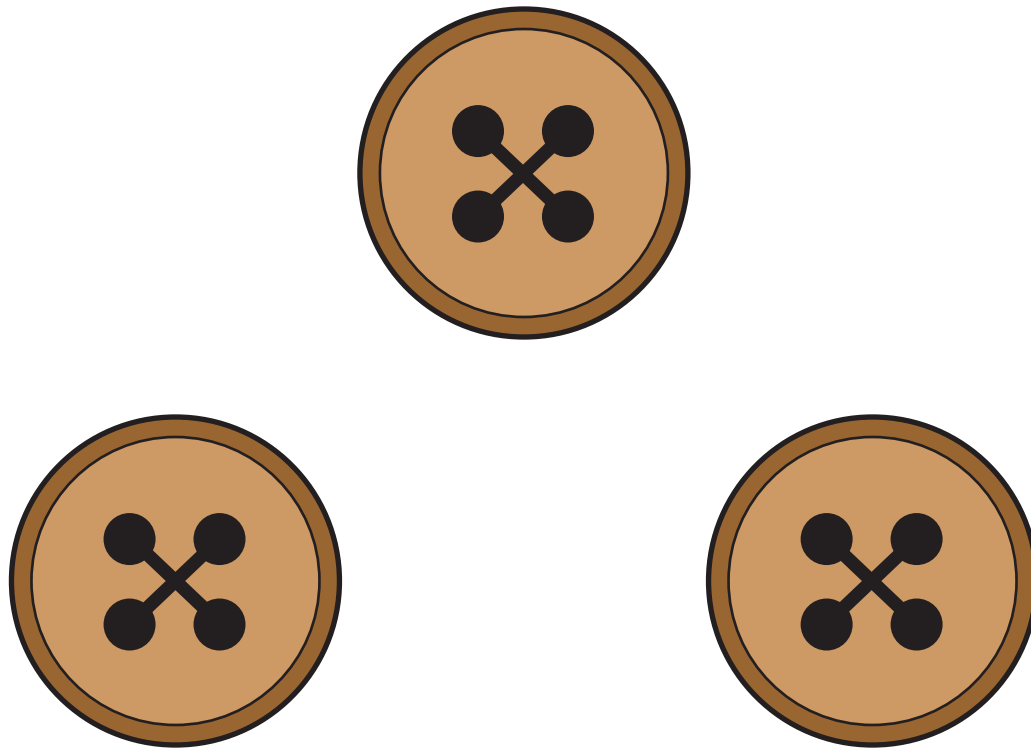

2b

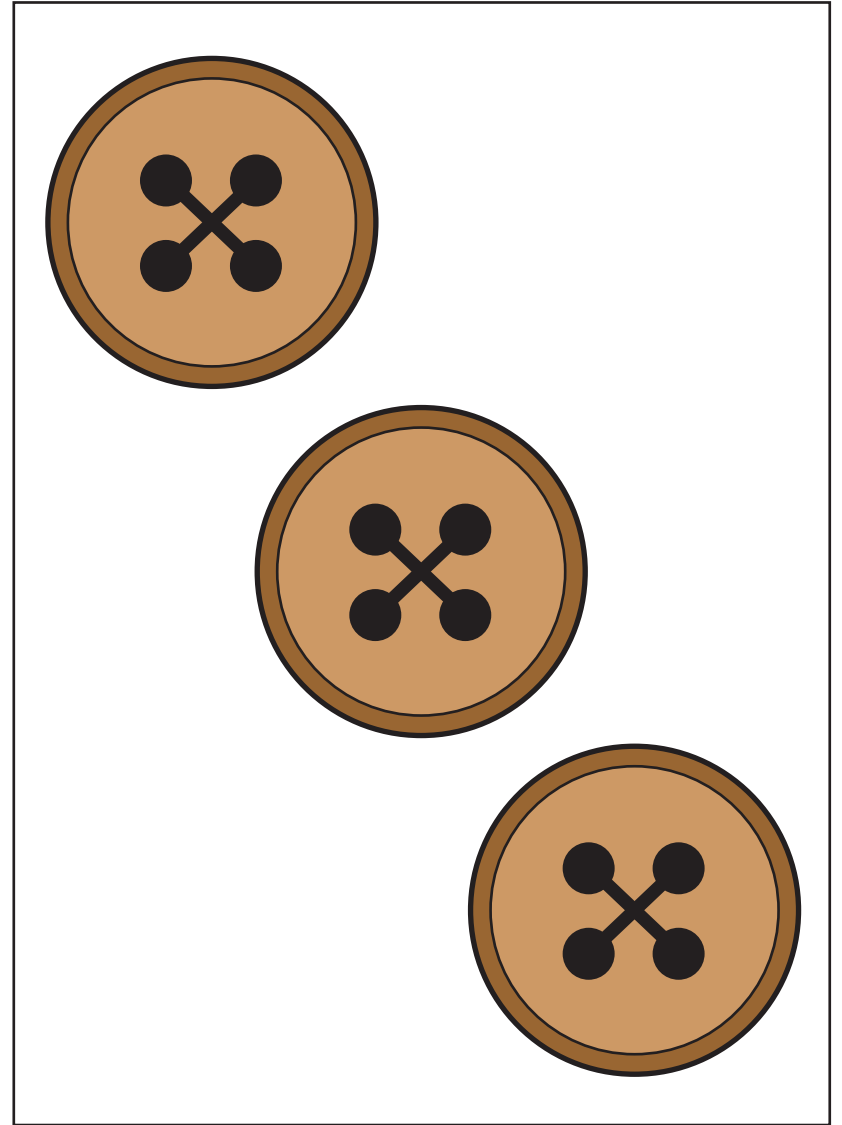
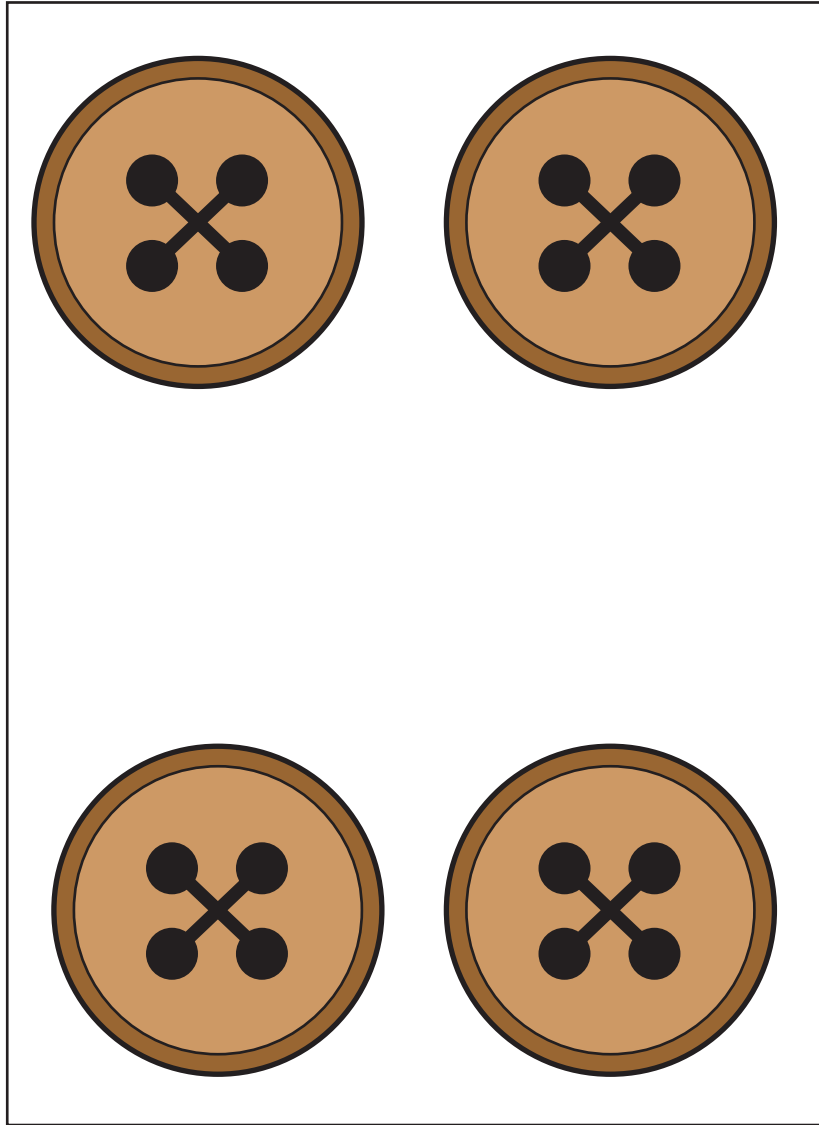

3a

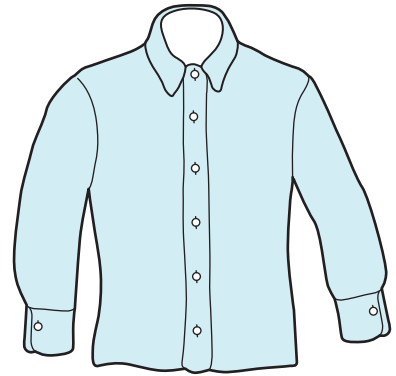
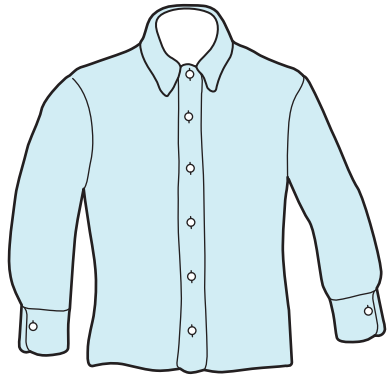

3b

6

2

5

2, 3, 4, 5, 6

2, 4, 5, 6, 7

2, 4, 6, 8, 10

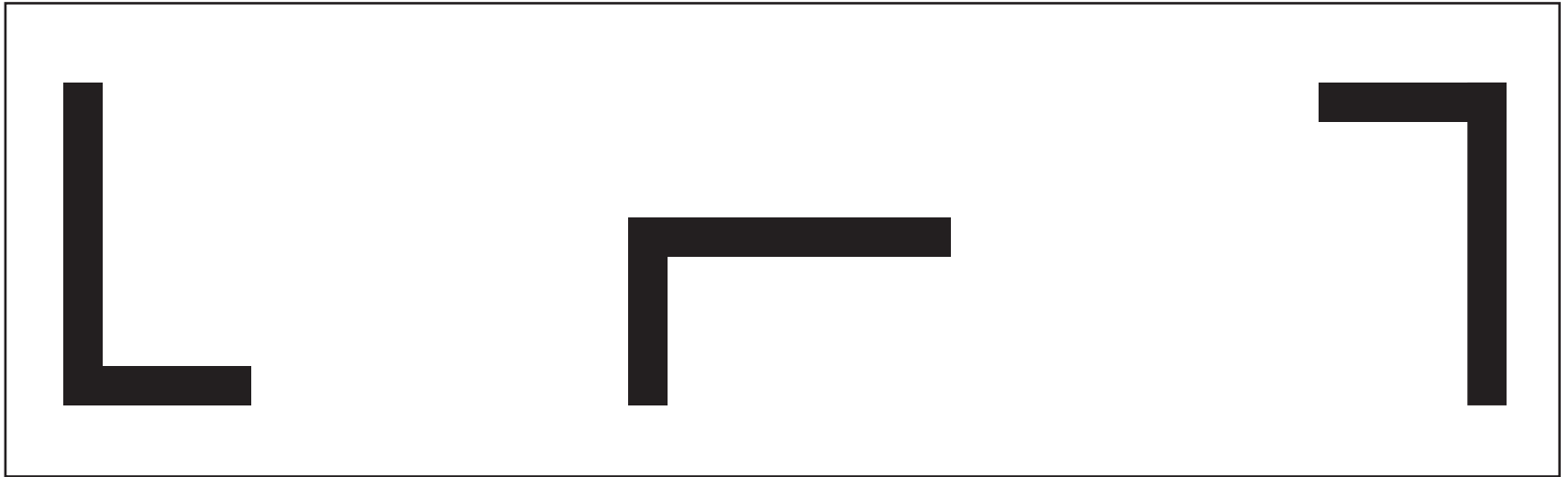

6a



6b

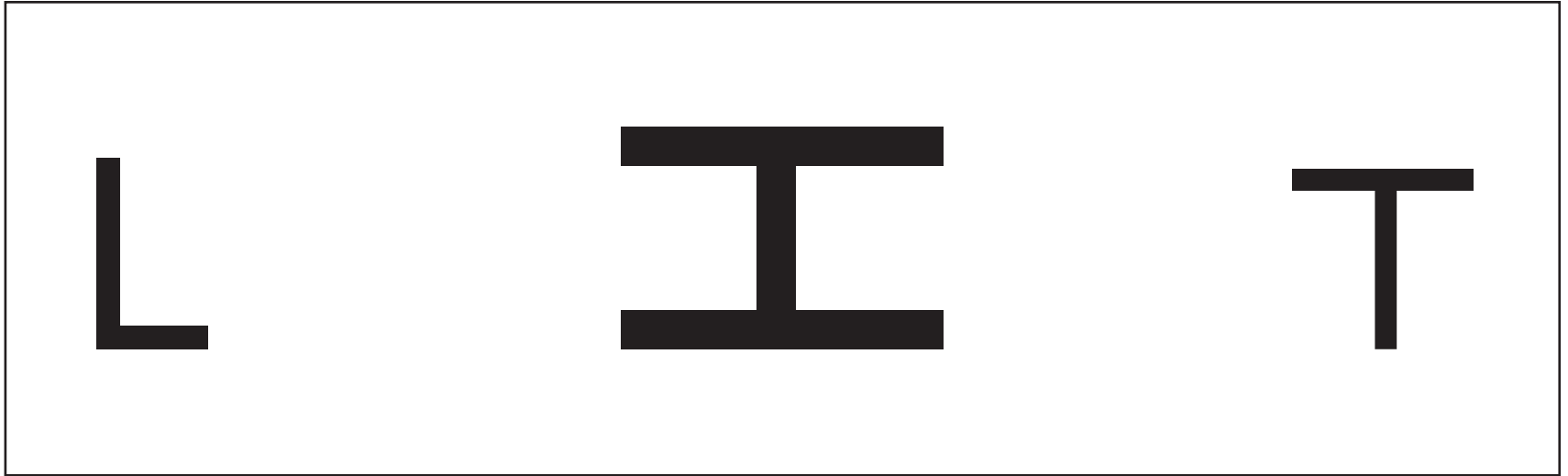

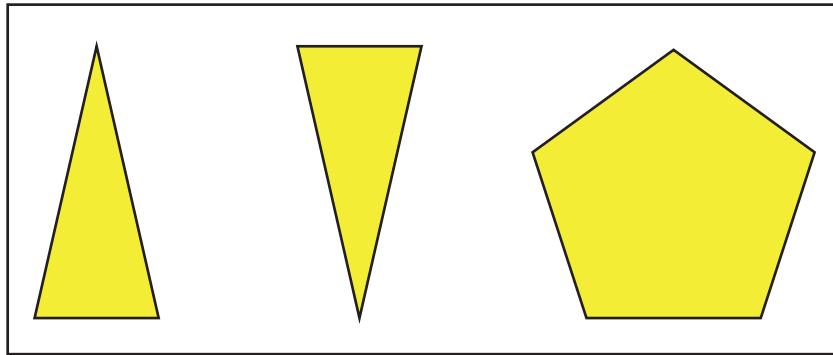
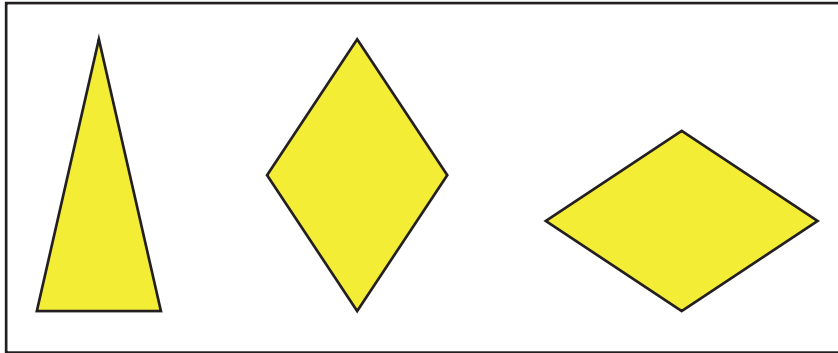
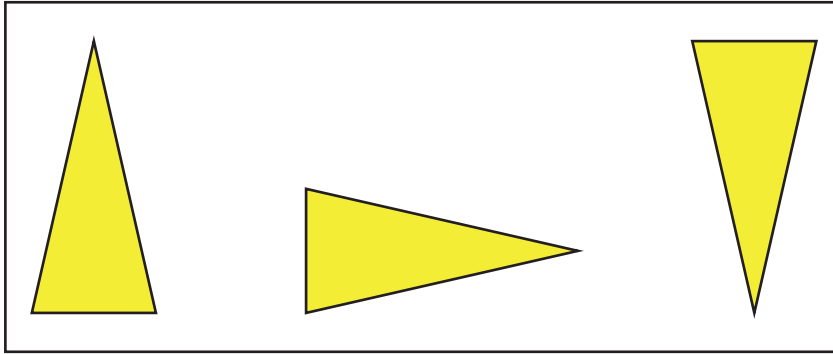

8a

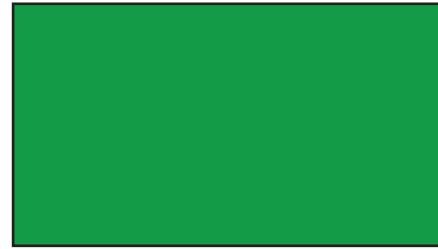
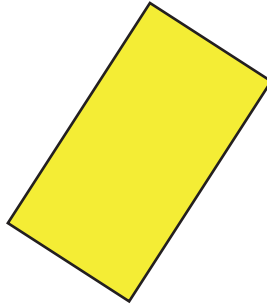

Each shape has 4 short sides and 2 long sides.

Each shape has 2 short sides and 2 long sides.

Each shape has 4 short sides and 4 long sides.

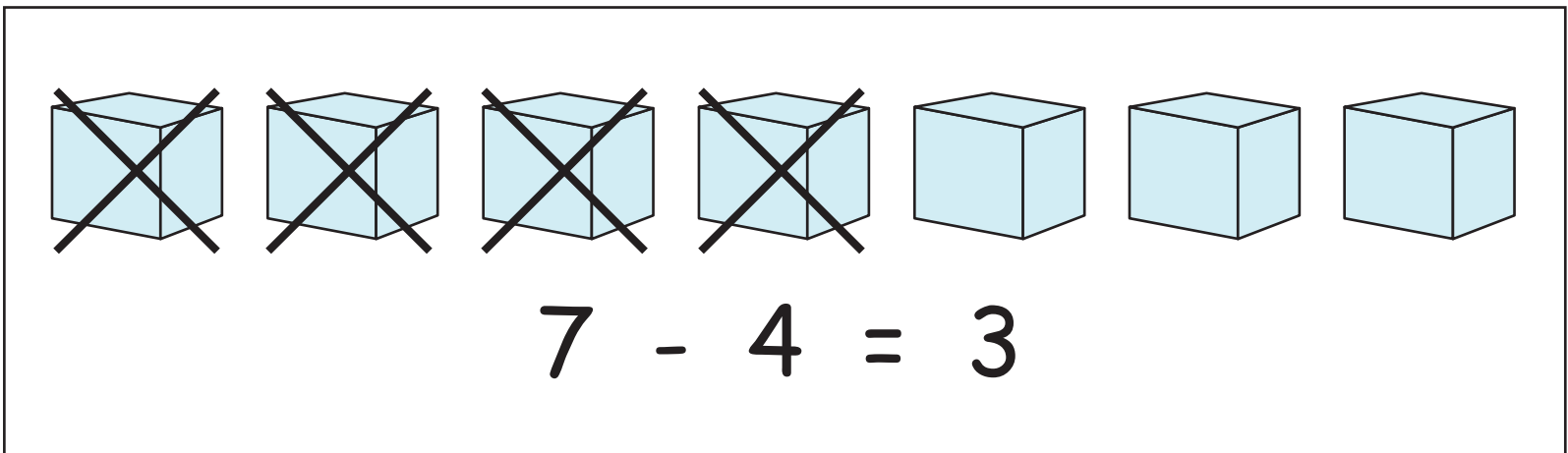
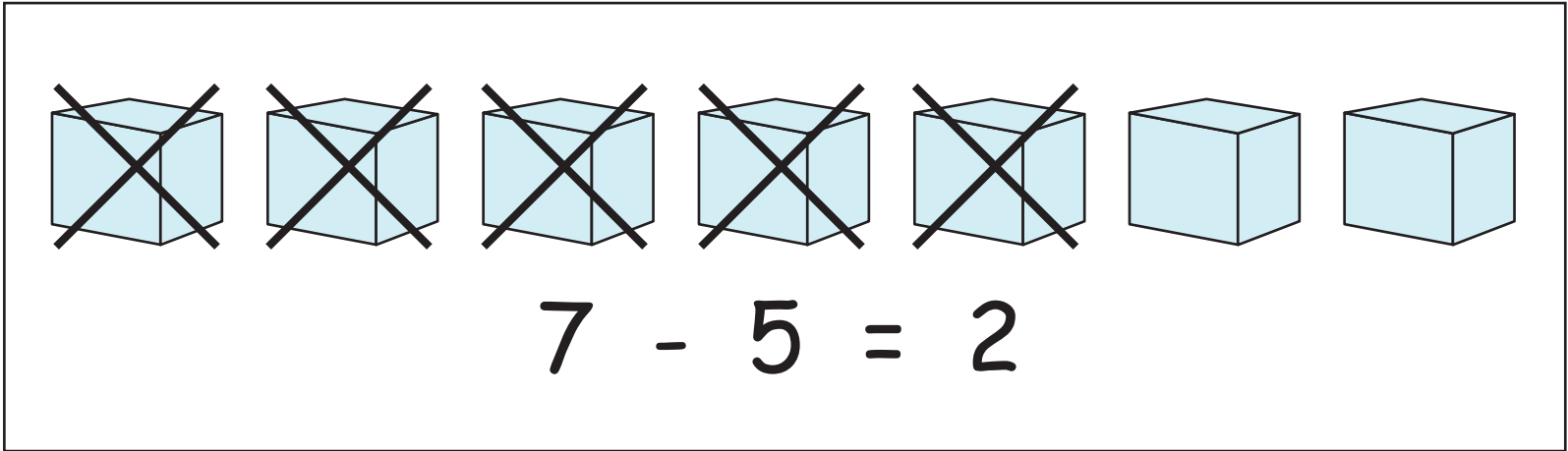

10a

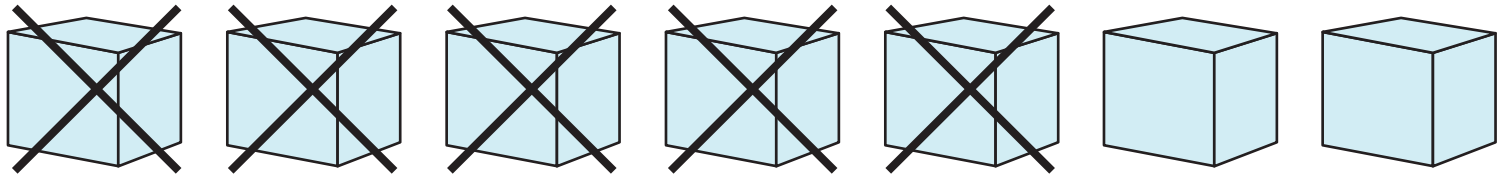

$$7 - 5 = 2$$

10b

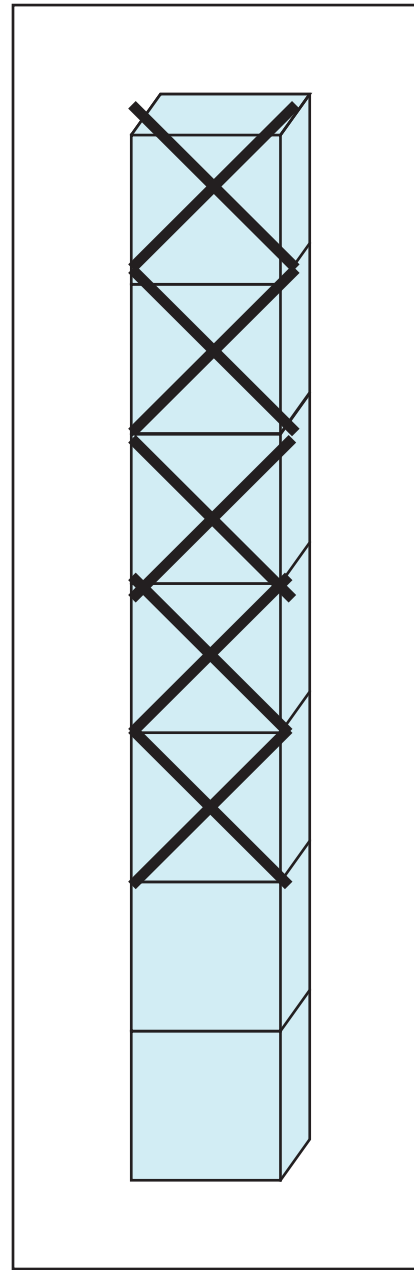
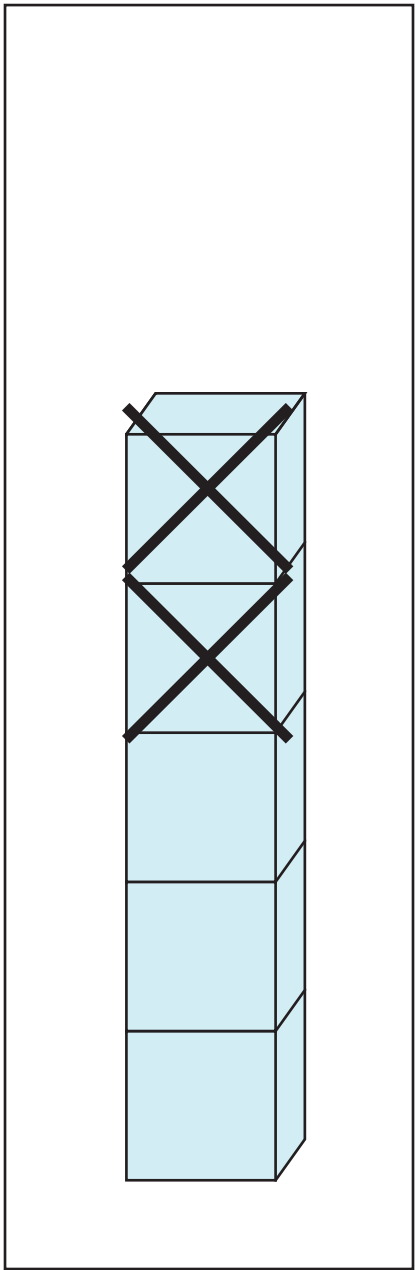

11a

$$5 - 2 = 4 - 1$$

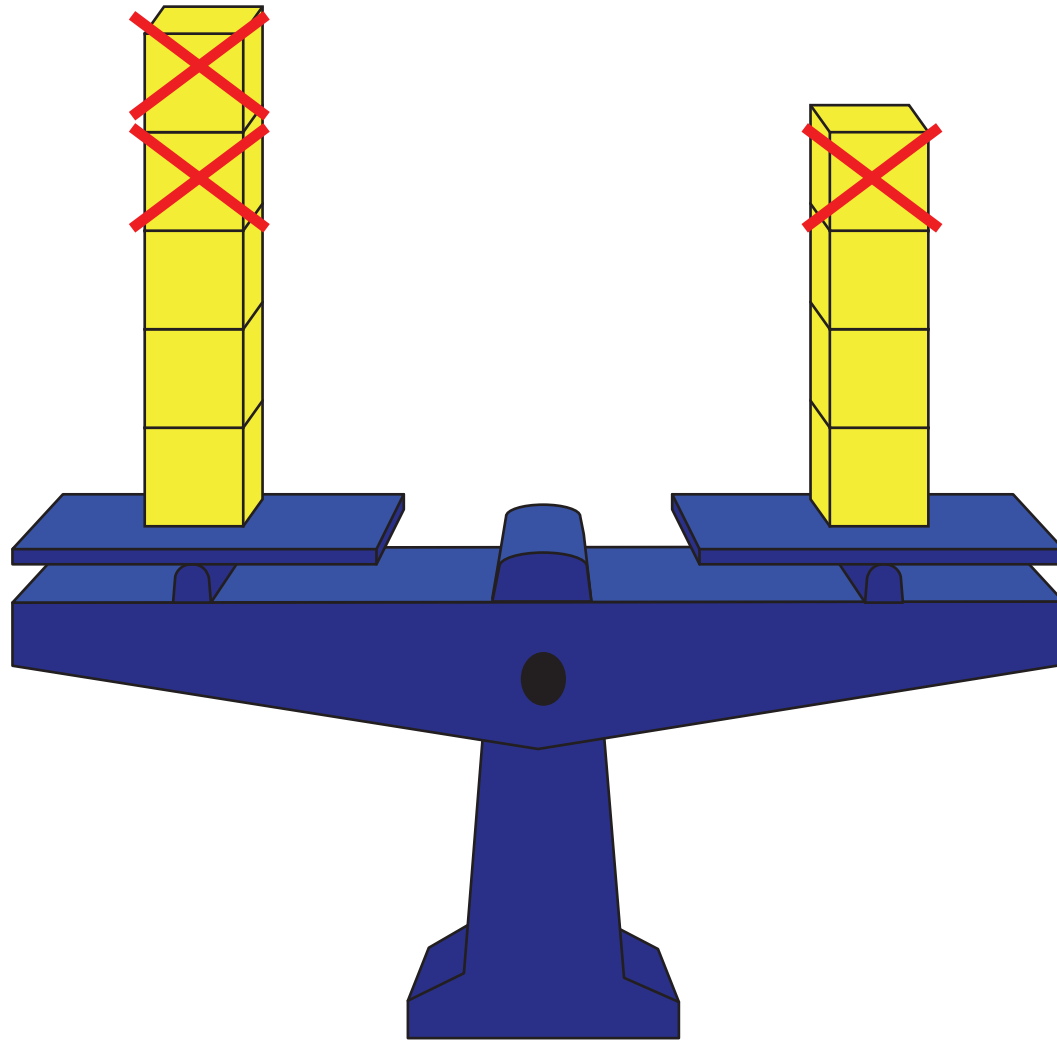

11b

9

3

5

12a

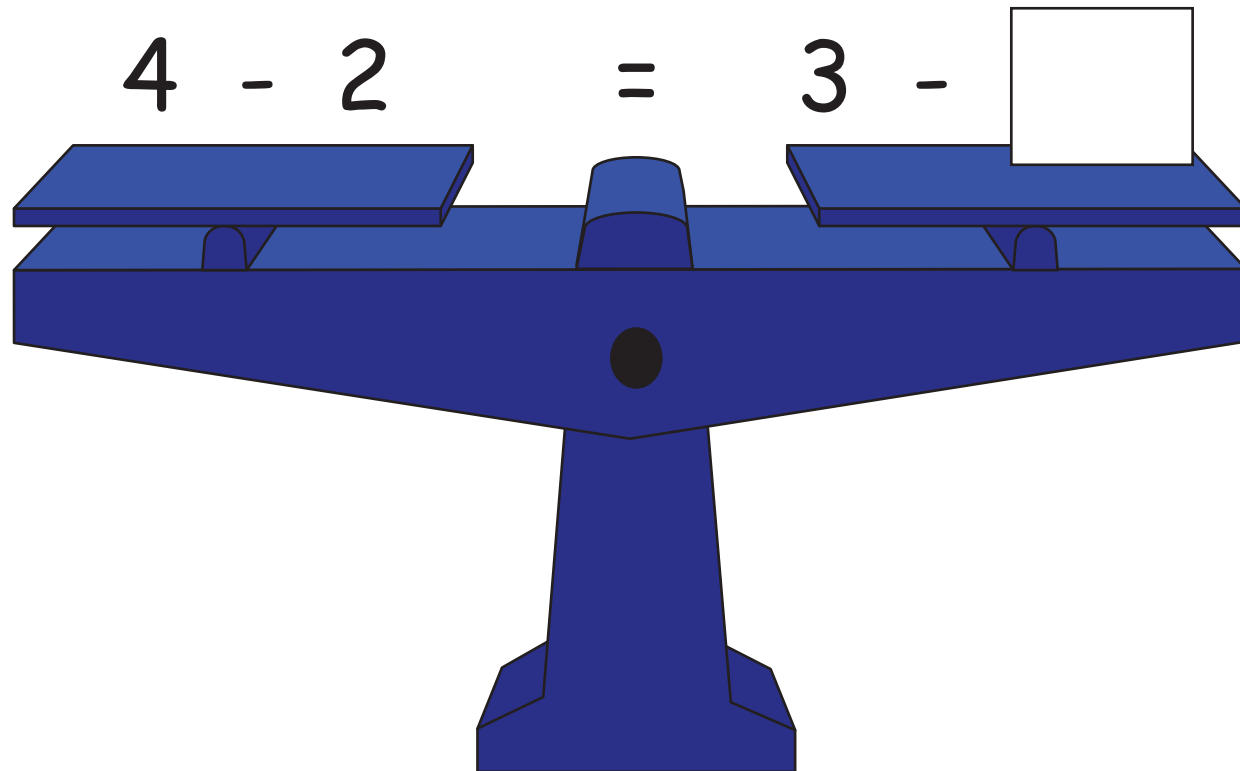

12b

3

6

1



14a

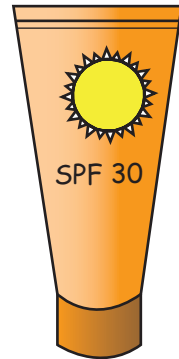

14b

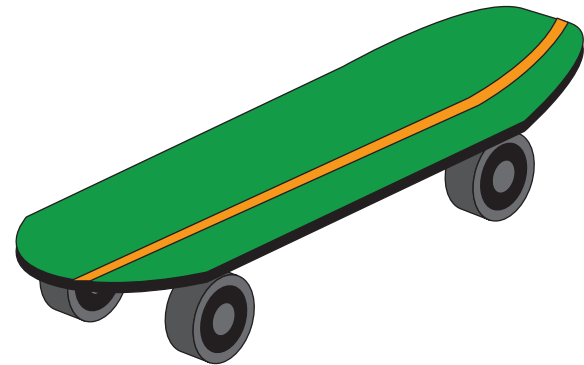
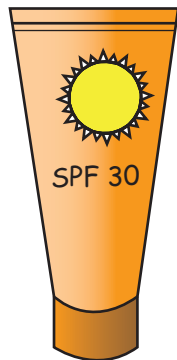

15a

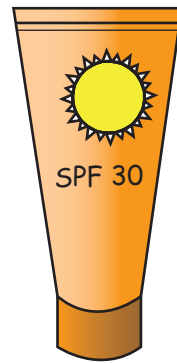

\$3

15b

spend \$1

spend \$3

save \$3

16a



\$5



The boy needs to —

save \$2 more for the helmet

save \$8 more for the helmet

save \$1 more for the helmet

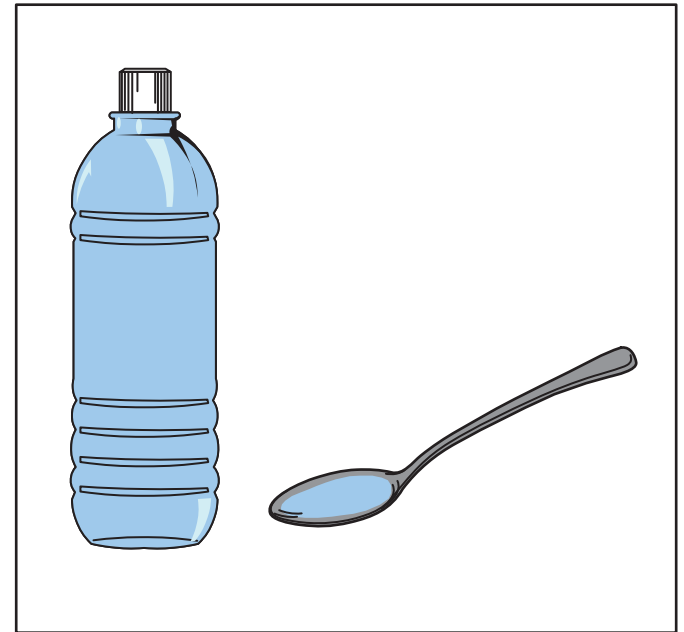
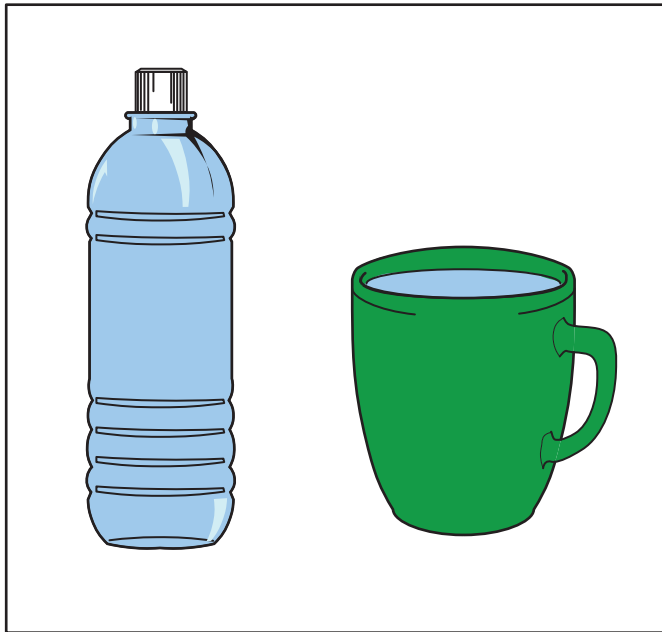

18a

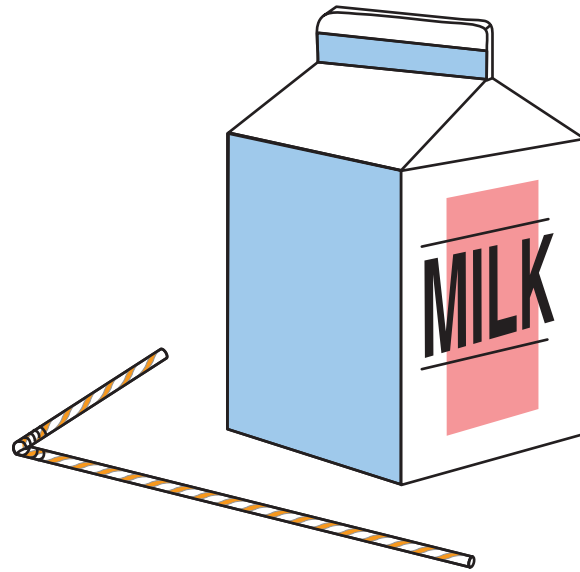

18b

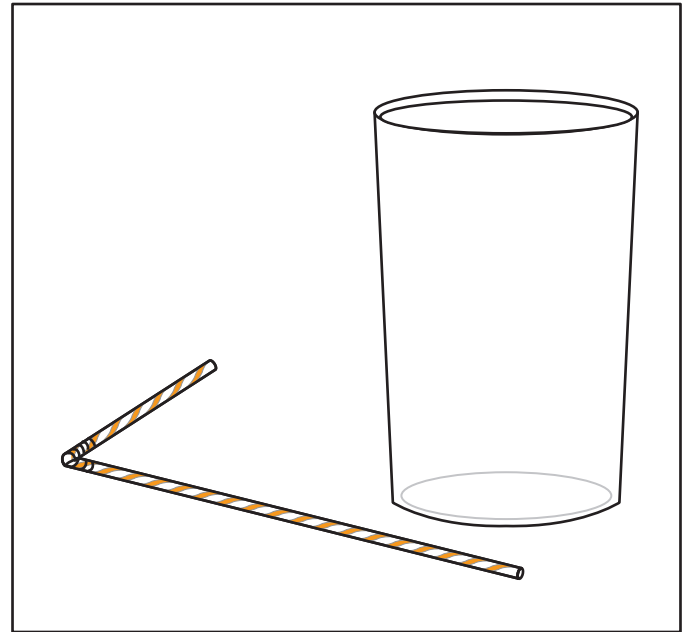
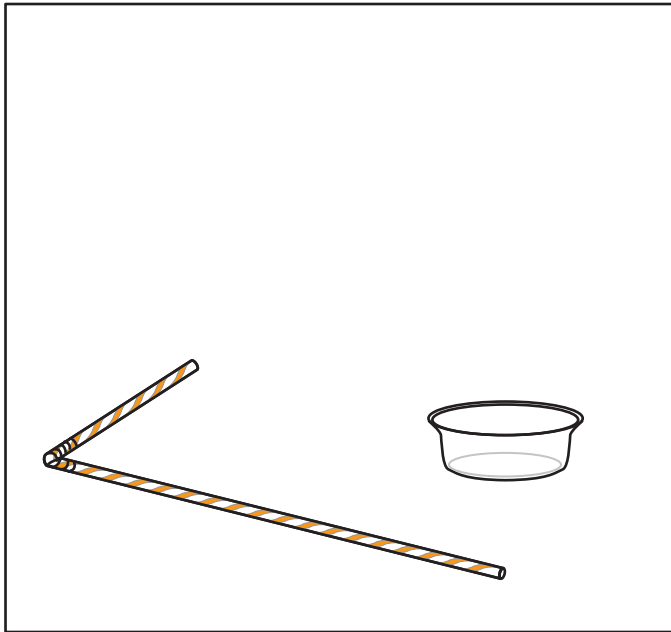

19a

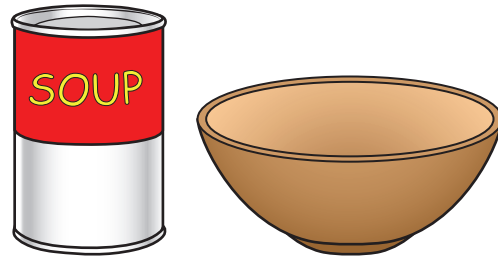

19b

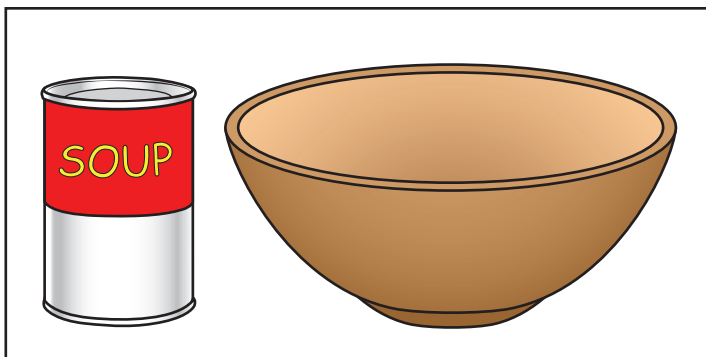
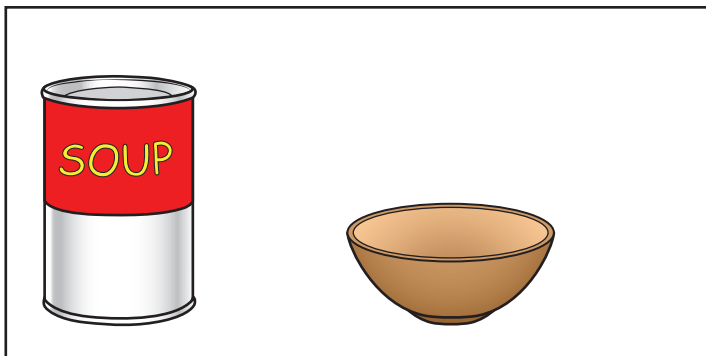
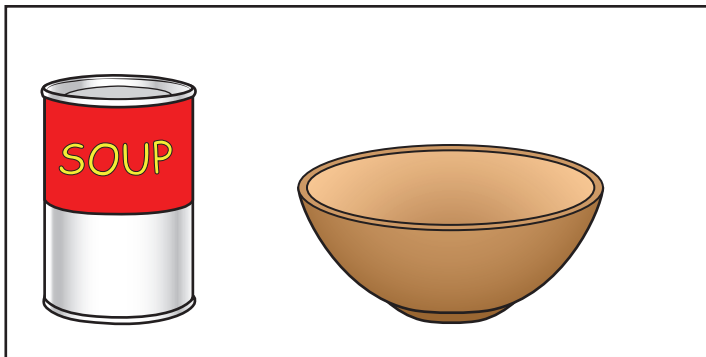

20a

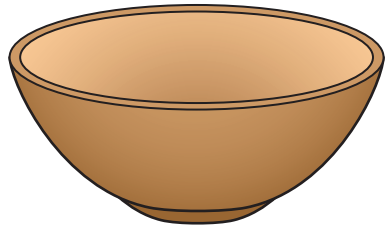

The bowl will hold more soup than the spoon.

The bowl will hold the same amount of soup as the spoon.

The spoon will hold more soup than the bowl.

**STAAR ALTERNATE 2
GRADE 3
Mathematics
April 2019**

ISD21060

Printed in the USA

1 2 3 4 5 A B C D E

1118798